

newline



Superior Image Quality



Remote Management



Go Wireless



Ultra light weight



Cloud access



Embedded Microphones



Remote Control



Device Compatibility

STREAMLINE YOUR SUCCESS

The NT Series is a non-touch display that brings your presentations to life in vivid Ultra-High Definition (4K) resolution. Focus on just the tools you need to succeed in your organization without paying for more features that you won't use.

Wirelessly cast to the screen from any mobile device, tablet, desktop, or laptop. Whether you use Windows, Mac, or Chrome, the NT Series lets you share your screen through a wireless connection or through the multiple I/O ports built into the panel. Access your files on your preferred Cloud storage system on the display. The built-in file viewer lets you easily navigate through local files, Cloud storage, and files from connected USB thumb drives.

Rediscover the simplicity of real innovation with the new NT Series.

Newline IP Series features the following interactive ecosystem tools:

CAST

BROADCAST

DISPLAY MANAGEMENT

NT Series

NIT Series

MODEL	TT-8519NT	TT-9819NT
Display		
Backlight	LED	
Active screen size	85"	98"
Display ratio	16:9	
Resolution	3840 x 2160 Pixel (4K)	
Display colors	8 bit (1.07 Billion)	10 bit (1.07 Billion)
Brightness	≥ 400cd/m2	
Contrast ratio (Dynamic)	4000:1	
Response time	8 ms	
Screen viewing angle	178°	
Life time	≥ 50,000 hours	
Speaker		
Speaker position	Forward	
Rated impedance	6Ω	
Max. power output	20W x 2	
Electrical		
Power consumption supported	Maximum ≤450W	Maximum ≤700W
Working voltage	AC 100-240V	
Transportation / Storage		
Outline dimension	1967x1152x87mm	2212x1293x93mm
Net weight	49 Kg	82 Kg
Gross weight	67 Kg	135 Kg
Packing dimensions	2101x275x1272mm	2440x450x1570mm
VESA	800 x 400 mm	800 x 600 mm
Smart System		
Chipset	Hi3751 V810	
CPU	A73*2+A53*2	
GPU	G51*4	
RAM	DDR4 3G	
ROM	16GB	
Android Version	8.0.0	
Speciality		
Wifi module	Pluggable WiFi module 7668U	
Firmware update	OTA	
Internal microphone	6 Microphone array, Echo cancellation, Beamforming, Noise reduction, Reverb removal	
Front button	Power buttonX1	
Back button	Rocker switch for power Up, Down, Left, Right, OK, Return, Menu	
Ports		
Rear input port	USB 3.0 x 4, HDMI x 4, USB 3.0 Type B (for touch, passthrough) x 1, LAN IN x 1, RS232 x 1 2.0; YPbPr x 1	
Rear output port	LAN OUTx1, SPDIF OUTx1, Earphonex1	

Technical drawings

TT-8519NT

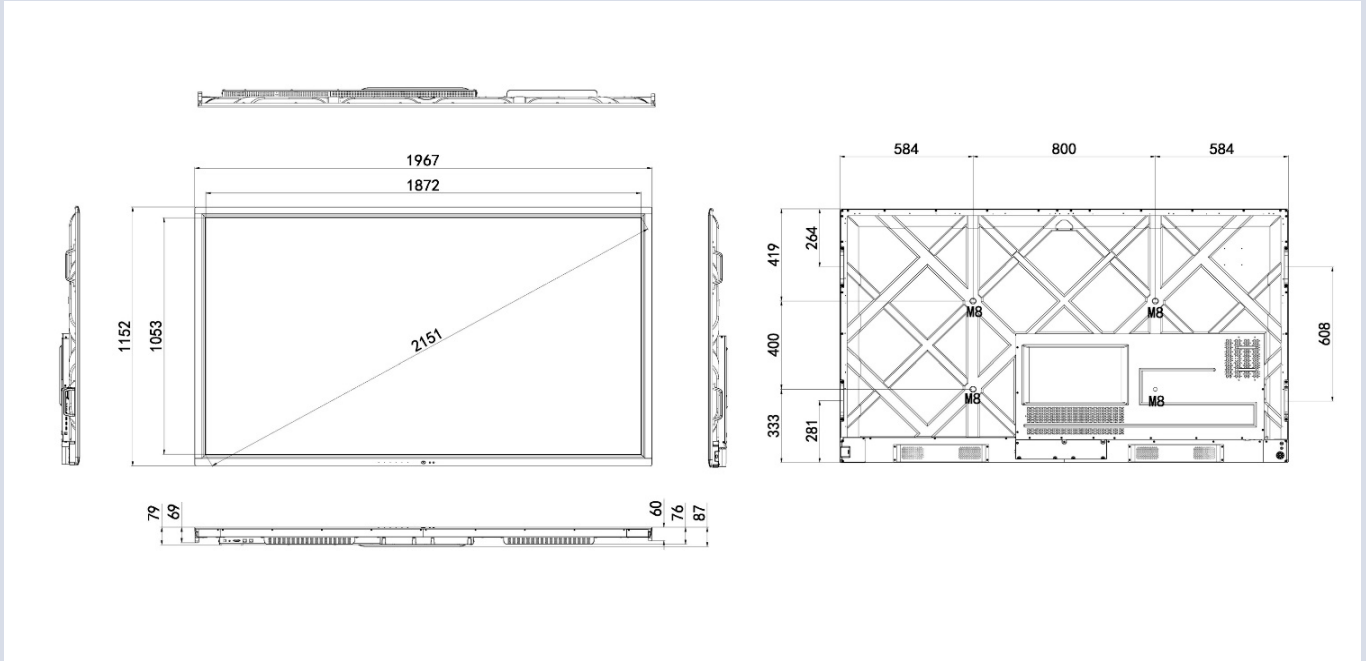

TT-9819NT

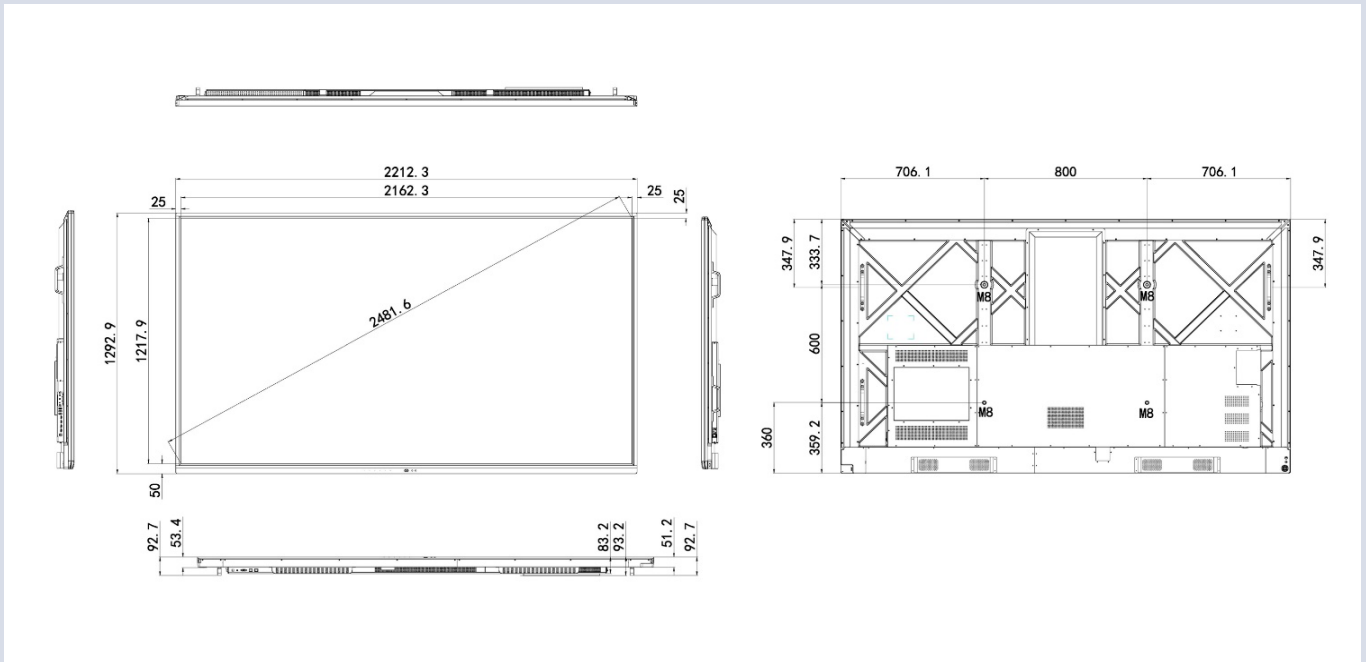

NT Series

Accessory Box Packing List

TT-8519NT

TT-9819NT

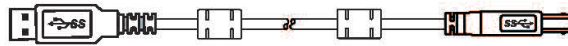

USB cable (A-B)

x1

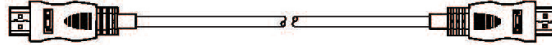

HDMI cable

x1

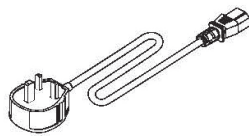

UK Power cord

x1

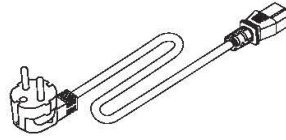

EU Power cord

x1

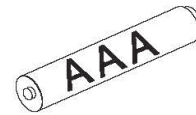

AAA Battery

x2



Remote control

x1

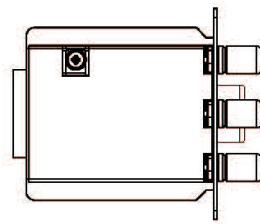

WiFi Module

x1

newline

NEWLINE INTERACTIVE INC.

101 East Park Blvd.
Suite 807 Plano,
TX 75074, USA
TEL: +1 888 233 0868

EUROPE OFFICE

Ronda de Poniente, N°2, 1st floor,
Oficina 1B, 28760,
Tres Cantos, Madrid, Spain
TEL: +34 911169178
info_eu@newline-interactive.com

ASIA PACIFIC OFFICE

17F, No. 653, Bannan Rd.,
Zhonghe Dist., New Taipei City
235, Taiwan
TEL: +886 282282089

INDIA OFFICE

Room No. 203, No.37, TTK Road,
Alwarpet, Chennai,
Tamil Nadu, India, 600018
TEL: +91 44 46945513

www.newline-interactive.com